

Technical Data Sheet

Wall Support - Light Duty Mounting Angle

Hot Dip Galvanized According to EN ISO 1461

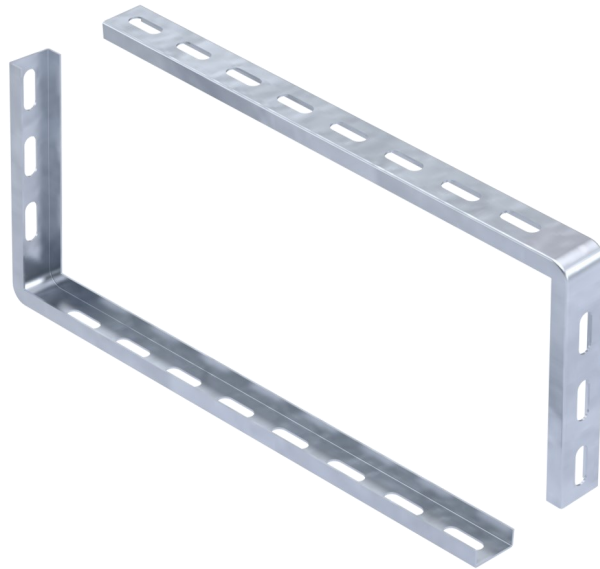

Master Data

Product Code	077.SA150400
Description 1	Wall Support
Description 2	Light Duty Mounting Angle
Dimension	150 x 400mm
Material	Steel
Surface Protection	Hot Dip Galvanized According to EN ISO 1461
Use	Outdoor / Wet Indoor Facilities

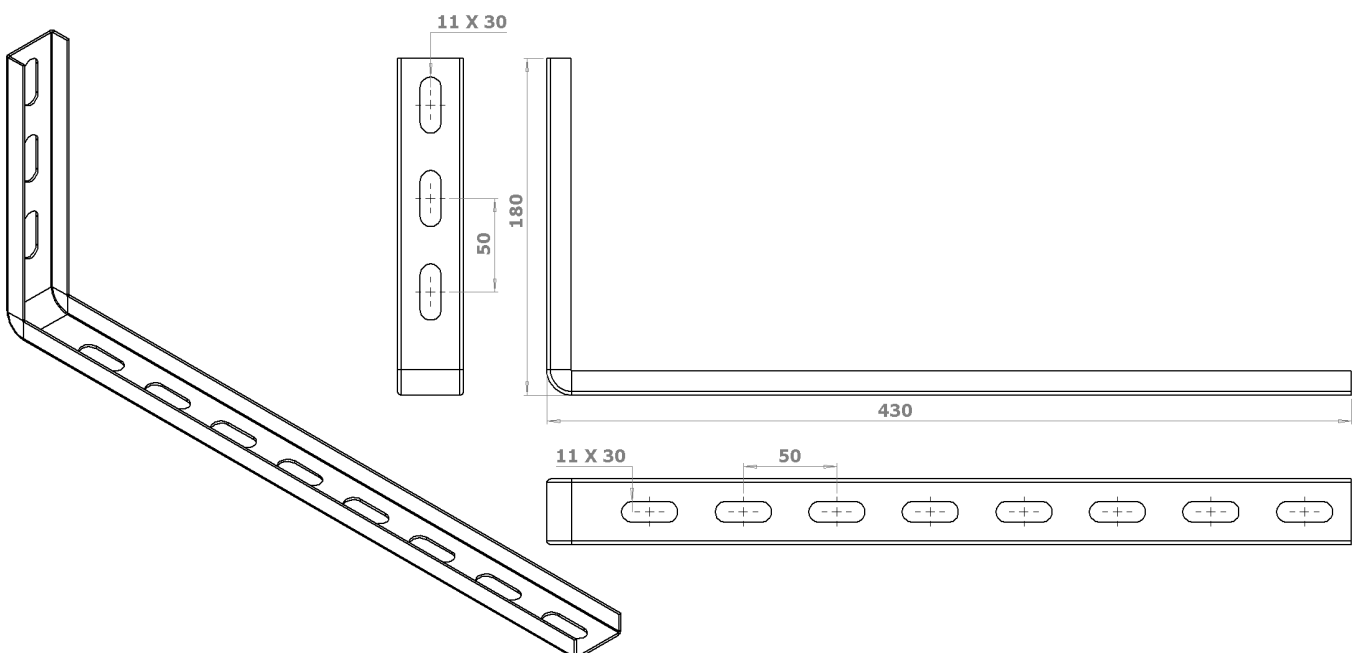

ISO 9001:2015